

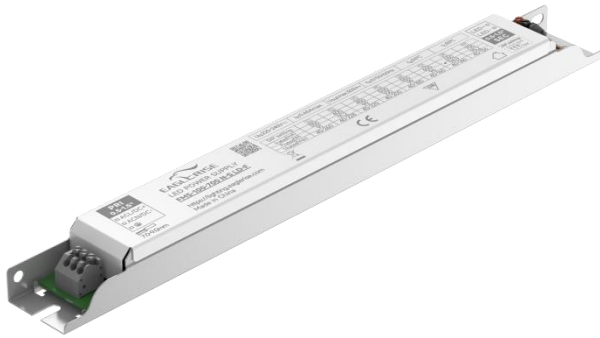

FMS-100-700 N-S LD-F

100W Constant Current -FMS Series



Approve



Features

- Class I , Non-isolated, Built-in
- Input Voltage :220-240VAC
- Protections: SCP/OVP/OTP
- Power Factor: 0.95(Typ.)
- Efficiency: ≥95%(Typ.)
- Adjustable Output Current with dip-switch
- 5 years warranty
- IP20

Applications

- Linear light

◆ Description

FMS-100-700 N-S LD-F is a 100W constant current LED driver that operates from 176-264Vac input with 350 to 700mA output current. The output current is adjustable by DIP Switch. With it's dimensions from 280 x 30 x 21mm. It is easy to integrate in linear light products. To ensure trouble-free operation, protection is provided against output short circuit, over voltage and over temperature.

◆ Model code

FMS-100-700 N-S LD-F

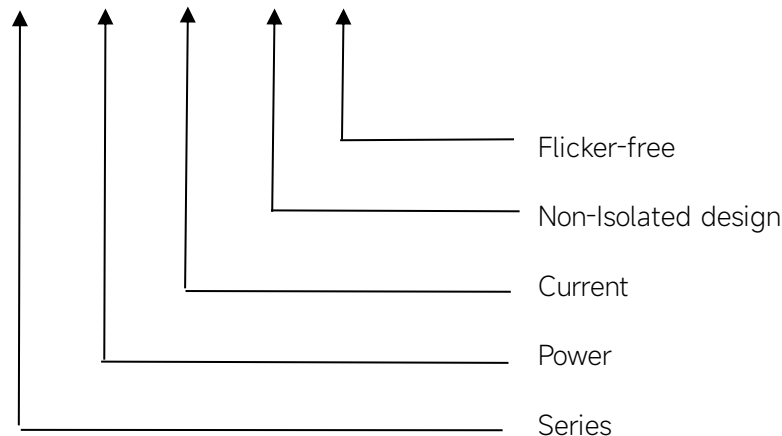

◆ Specification

Output	Constant Current	350mA	400mA	450mA	...mA	700mA
	Voltage Range	40-260VDC	40-228VDC	40-220VDC	...VDC	40-136VDC
	Unload voltage Max.(VDC)	300VDC				
	Current Accuracy	±5%				
	Output HF current ripple(≥1KHz)	±5%				
	Output LF current ripple(≤120Hz)	±5%				
	SVM	≤0.4				
	Pst	≤1				
	Efficiency(Typ.)	95%@≤500mA,94%@≥550mA				
Input	Rated input voltage	220-240V				
	Range of input voltage	198-264VAC				
	Maximum voltage	300VAC@1 h maximum,unit might not operate in this abnormal condition				
	Range of input DC voltage(VDC)	176-280VDC				
	Frequency(Hz)	0/50/60 Hz				
	Displacement factor	≥0.9				
	Power Factor	0.95@Full load ,220-240V				
	Input Current max	0.65A				
	Start-up time	< 0.5S				
	No Load Power	≤0.5W				
	THD (Typ.)	<10% @Full load ,220-240V				
Protection	Over Load Protection	>105%				
		YES/Auto Resume				
	Over Voltage Protection	YES/Auto Resume				
	YES/Auto Resume					
Capability	Surge capability (L-N)	1KV				
	Surge capability (L/N-Ground)	2KV				
Environment	Operating Temperature	-20°C ~+50°C				
	Humidity	20%-90% RH				
	Tc	85°C				
	Storage Temperature	-25°C ~+60°C				
	Life time	> 50000h@Tc=75°C ,230VAC				
	Noise	≤25dB(A)@20cm				
Surface	Dimension	280 x 30 x 21(LXWXH)mm				
	material	metal case				
Standards	Safety	IEC61347- 1, IEC61347-2- 13;EN61347- 1, EN61347-2- 13;EN61347- 1, EN61347-2- 13, EN62384				
	EMC	EN55015, EN61000-3-2, EN61000-3-3, EN61547;EN61000-4-2,3,4,5,6,8,11, EN61547				
	ErP	Erp2.0 EU 2019/2020				

	RoHS	RoHS (2011/65/EU) (EU)2015/863
Note	<p>1.All parameters not specially mentioned are measured at 230VAC input, full load and 25°C of ambient temperature.</p> <p>2.Ripple & Noise are measured at 20MHz of bandwidth by using a 300mm twisted pair-wire terminated with a 0.1uF & 47 uF parallel capacitor.</p> <p>3.The DC input for this product is only used for emergency lighting and applies to functional and safety requirements , EMC is not considered.</p> <p>4.EL compatible with IEC 61347-2-13 Annex J, compatible with EN 60598-2-22 emergency lighting fixtures, compatible with EN 50172 central battery system applications.</p> <p>5.The current with load range cannot exceed 130% of the maximum power at full load.</p> <p>6.The over-temperature protection of the product is provided by the IC.</p> <p>7.All Eaglerise power supply are complied with EMI regulations. Since they are belong to component and will be installed inside system enclosure. When they are integrated into a system, the EMI characteristics of the system must be re-verified again.</p>	

◆ Parameter

Number	Output				Switch position		
	Current (mA)	Voltage (VDC)	Voltage No load (VDC)	Power (W)	1	2	3
1	350mA	40-260VDC	300VDC	91	--	--	--
2	400mA	40-228VDC		91.2	ON	--	--
3	450mA	40-220VDC		99	--	ON	--
4	500mA	40-200VDC		100	ON	ON	--
5	550mA	40-180VDC		99	--	--	ON
6	600mA	40-160VDC		96	ON	--	ON
7	650mA	40-146VDC		94.9	--	ON	ON
*8	700mA	40-136VDC		95.2	ON	ON	ON

* Factory default

◆ Inrush Current

I _{peak}	T _{width}	B10	B16	B20	C10	C16	C20
42A	214μs	9pcs	14pcs	18pcs	12pcs	19pcs	24pcs

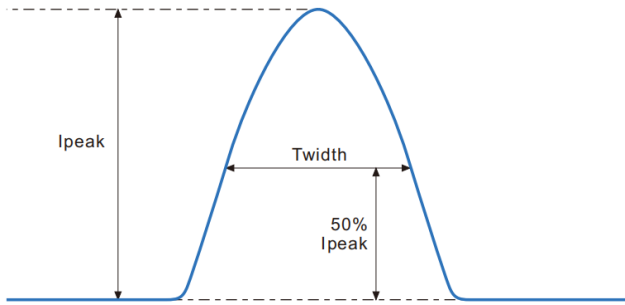

Remarks:

- 1.The number of drives mounted under different MCBs in the table is the maximum value. Please do not exceed this number during installation.
- 2.Different brands and models of miniature circuit breakers, the number of drives mounted will be slightly different.

◆ Wiring diagram

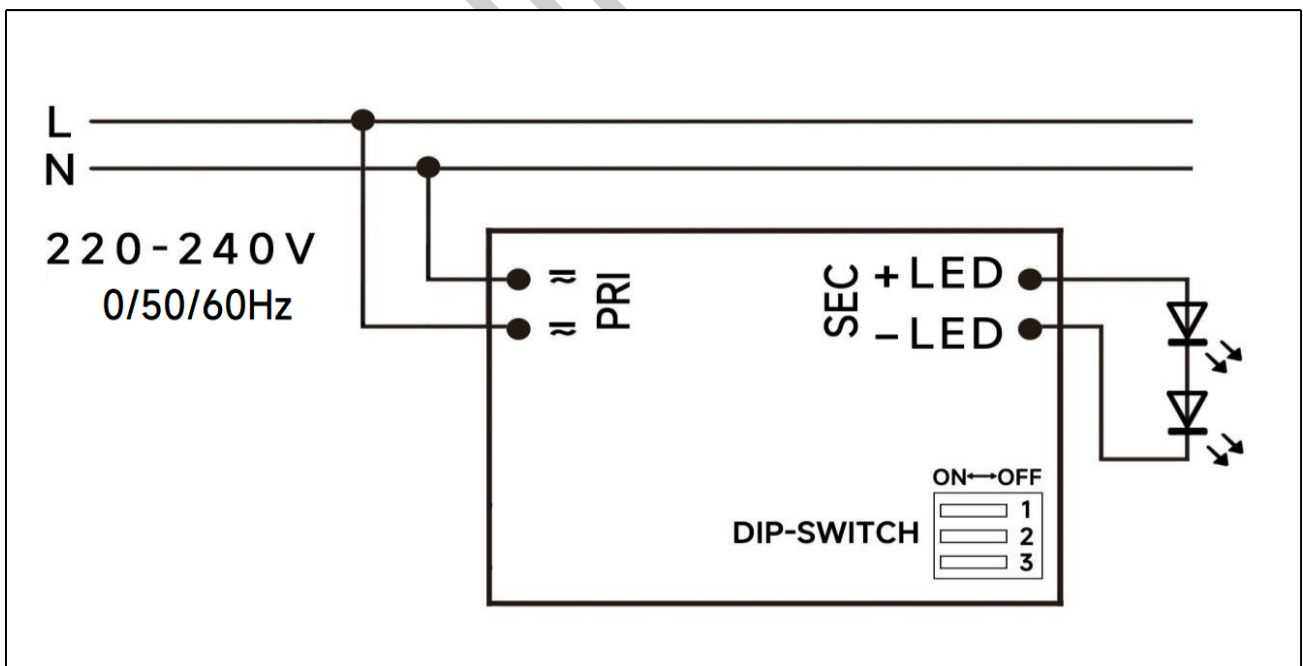

◆ 2D diagram

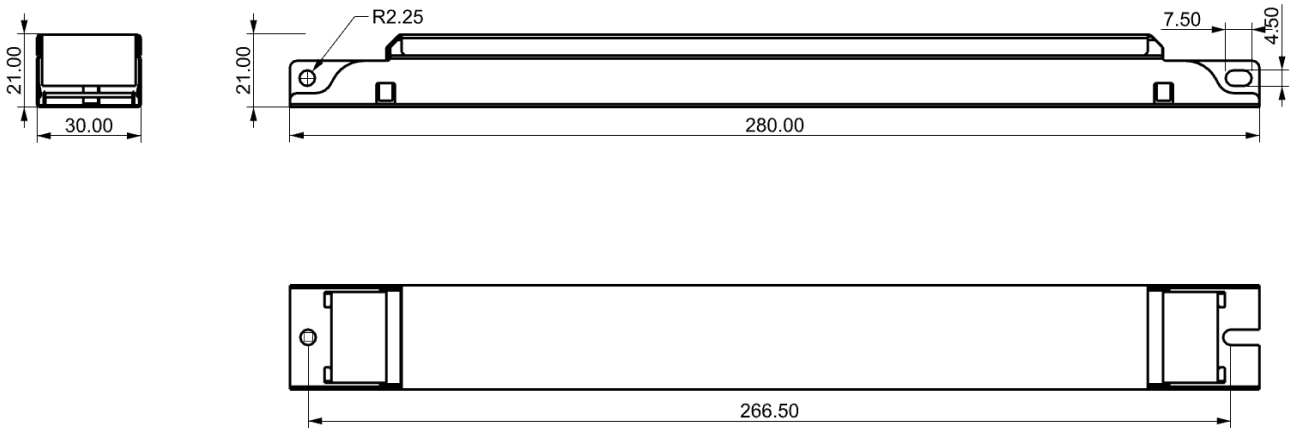

◆ Wiring & Connections

	Specification item	Value (Unit)
Input	Input wire cross-section	0.5...1.5 mm ²
	Input wire gauge.	16...20 AWG
	Input wire strip length	7...9mm
Output	Output wire cross-section	0.5...1.5 mm ²
	Output wire gauge.	16...20 AWG
	Output wire strip length	7...9mm

Note: Solid wire is risky to use on an angled terminal. Stranded wire is recommended for this kind of use.

◆ Curve for FMS-100-700 N-S LD-F, $I_o=700\text{mA}$

Lifetime vs. Temperature Curve

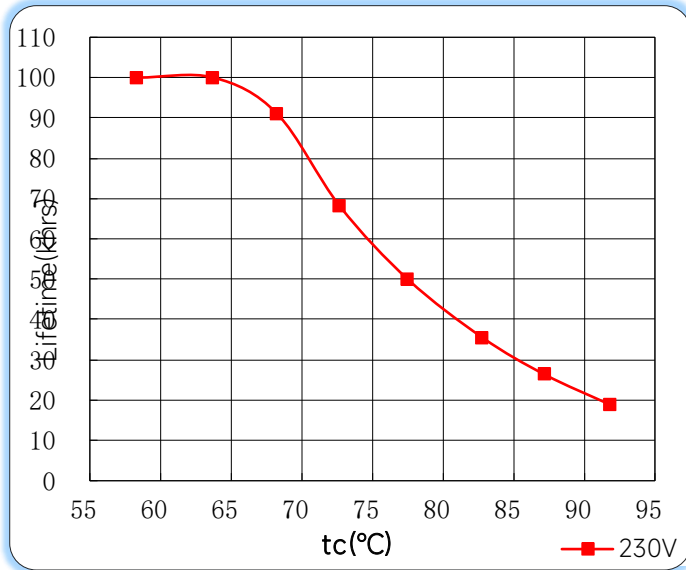

Efficiency vs. Load

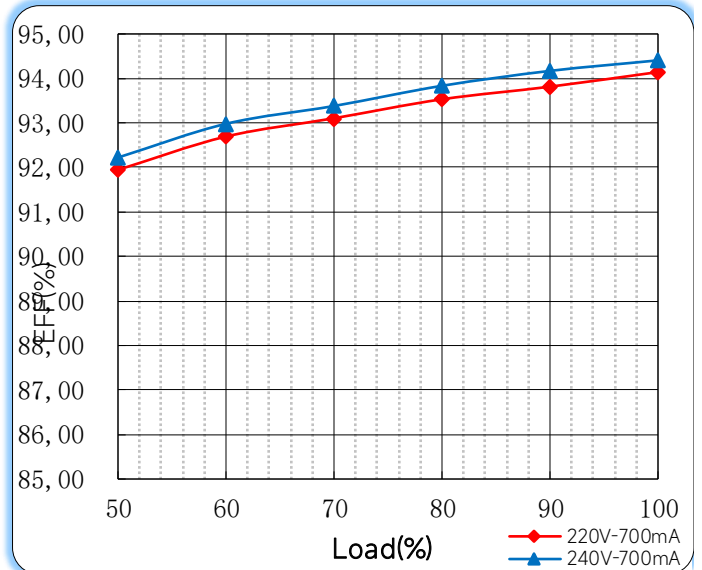

Power Factor Characteristics

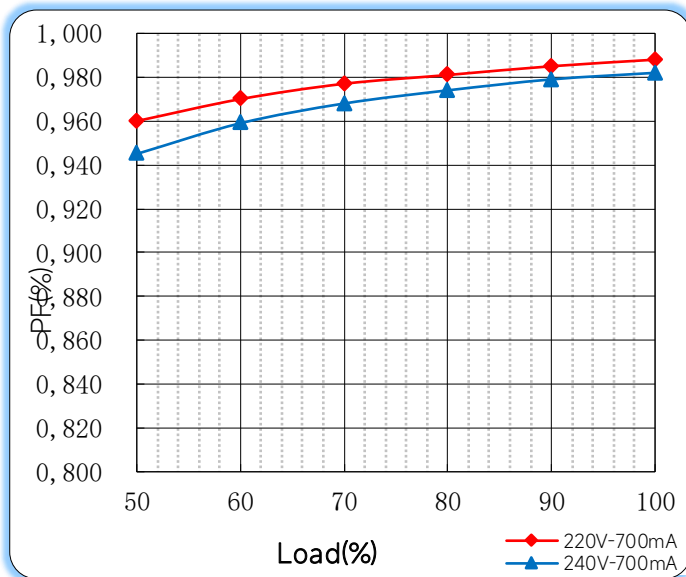

THD vs. Load

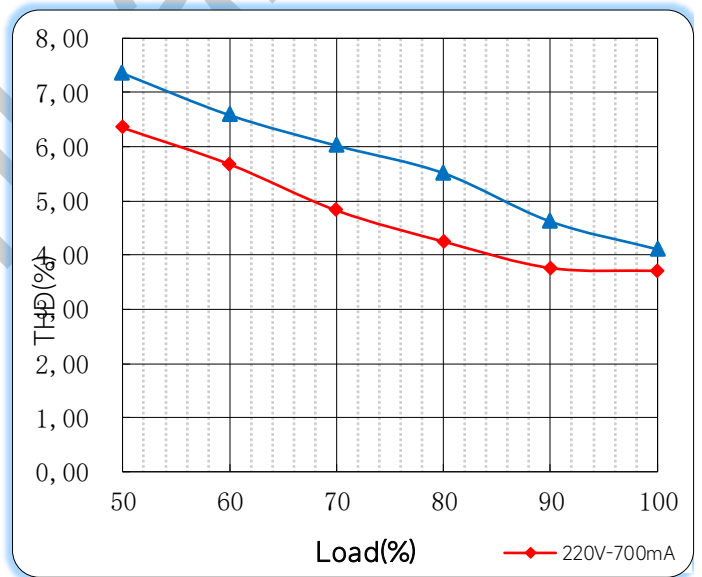

◆ Operating window

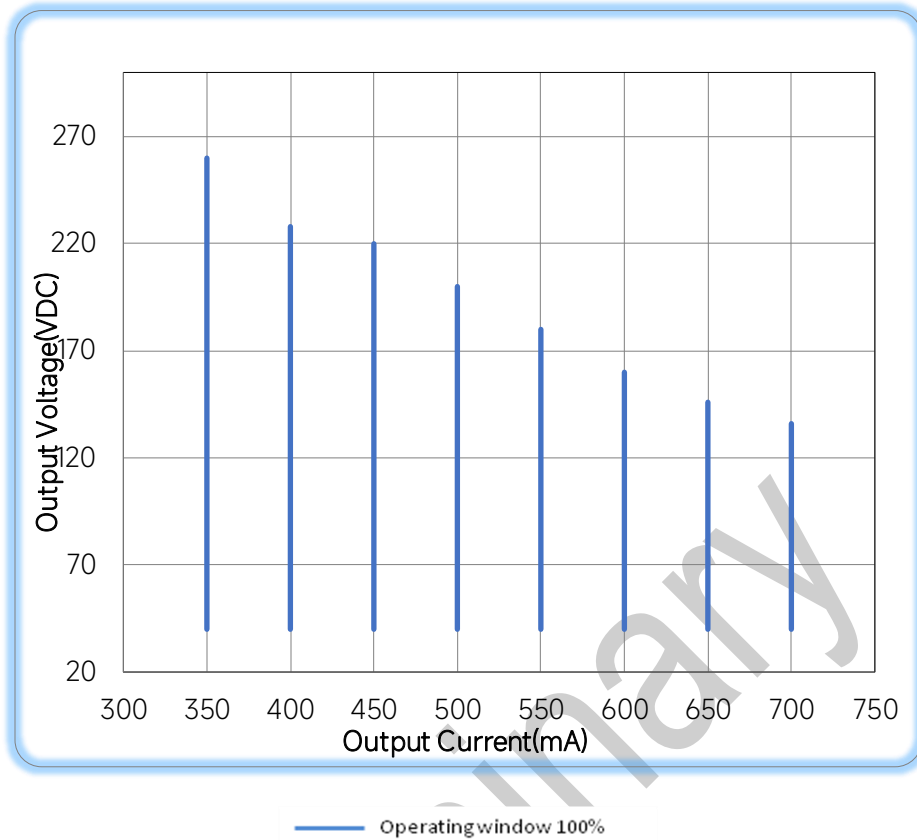

◆ Revision Updates

ITEM	BEFORE	AFTER	VERSION	DATE
Initial			A	2024/04/12
Unload voltage Max.(VDC)	280VDC	300VDC	B	2024/10/14

Remark: The final interpretation of the contents of the specification belongs to Eaglerise Electric & Electronic (China) Co., Ltd.



Citi-el



+7 (499) 647-80-74

zakaz@citi-el.ru